

Lidar Mapping Report

Acquisition, Processing, and Delivery of Airborne Lidar Elevation Data for 140G0223F0145-MN_RiverWest_B23

USGS CONTRACT: 140G0221D0011 (GPSC4)

CONTRACTOR: Merrick-Surdex Joint Venture, LLP
(MSJV)

TASK ORDER NUMBER: 140G0223F0145

TASK ORDER NAME: MN_RiverWest_B23

- **PRJ_ID:** 300079
- **WU_IDs:** 300408

USGS National Geospatial Technical Operation Center

tnm_help@usgs.gov

Contract Project Manager:

Doug Jacoby
Merrick-Surdex Joint Venture, LLP
5970 Greenwood Plaza Blvd.
Greenwood Village, CO 80111
(303) 353-3903 (o)
(303) 521-6522 (c)
doug.jacoby@Merrick.com

Submitted To



Submitted by:



MSJV Job No. A00060.00

Table of Contents

Glossary of Terms	2
Project Summary	4
Project Report	5
Lidar Flight Information	5
Aerial Mission(s)	7
GNSS / IMU Data.....	8
GNSS Controls.....	8
Acquisition Data Check.....	8
Relative Accuracy – flight line to flight line.....	13
Smooth Surface Precision (intraswath)	13
Unfiltered Lidar Control Point Report.....	14
Lidar Control Point Layout	15
Lidar Filtering and Classification	15
Filtered Lidar Checkpoint Report.....	17
Hydro-flattening Breakline Collection	18
Bare-earth Digital Elevation Model (DEM)	21
Maximum Surface Height Raster (MSHR).....	21
List of Deliverables.....	21
Appendix 1.....	23

Glossary of Terms

Term	Description
AGL	Above Ground Level
AGPS	Airborne Global Positioning System
AGNSS	Airborne Global Navigation Satellite System
ANPD	Aggregate Nominal Pulse Density
ANPS	Aggregate Nominal Pulse Spacing
ASPRS	American Society of Photogrammetry and Remote Sensing
AT	Aerial Triangulation
CD	Compact Disk
CMS	Certified Mapping Scientist
CORS	Continuous Operating Reference Station
CP	Certified Photogrammetrist
CRS	Coordinate Reference System
CVA	Consolidated Vertical Accuracy
DEM	Digital Elevation Model
DFIRM	Digital Flood Insurance Rate Maps
DPA	Defined Project Area
DSM	Digital Surface Model
DTM	Digital Terrain Model
DVD	Digital Versatile Disk / Digital Video Disk
DXF	Data Exchange Format / Drawing Interchange
FIRM	Flood Insurance Rate Maps
FEMA	Federal Emergency Management
FGDC	Federal Geographic Data Committee
FVA	Fundamental Vertical Accuracy
FY	Fiscal Year
GIS	Geographic Information System
GISP	Geographic Information System Professional
GNSS	Global Navigation Satellite System
GPS	Global Positioning System
GSD	Ground Sample Distance
HARN	High Accuracy Reference Network
HDD	Hard Drive Disk
HPGN	High Precision Geodetic Network
IMU	Inertial Measurement Unit
INS	Inertial Navigation System
LAS	(or .las) – industry accepted LIDAR data exchange file format
LB	License Business
LS	Land Surveyor
LIDAR	(or Lidar) Light Detection And Ranging
MARS®	Merrick Advanced Remote Sensing
MSJV	Merrick-Surdex Joint Venture, LLP
MSL	Mean Sea Level
NAD	North American Datum
NDEP	National Digital Elevation Program
NGP	National Geospatial Program
NGS	National Geodetic Survey
NMAS	National Map Accuracy Standards

No.	Number
NPS	Nominal Point Spacing
NSRS	National Spatial Reference System
NSSDA	National Standard for Spatial Data
NVA	Non-vegetated Vertical Accuracy
OPUS	Online Positioning User Service
PDOP	Positional Dilution Of Precision
PLS	Professional Land Surveyor
PLSS	Public Land Survey System
ppsm	Points (or pulses) per square meter
PSM	Professional Surveyor and Mapper
QL1	Quality Level One
QL2	Quality Level Two
RLS	Registered Land Surveyor
RGB	Red, Green, Blue (i.e., three-band image)
RGBNIR	Red, Green, Blue, Near Infra-Red (i.e., four-band image)
RMSE	Root Mean Square Error
SBET	Smoothed Best Estimated Trajectory
SHA	Secured Hash Standard
SPCS	State Plane Coordinate System
SVA	Supplemental Vertical Accuracy
TIN	Triangular Irregular Network
USGS	United States Geological Survey
VVA	Vegetated Vertical Accuracy
WP_ID	Work Package ID (USGS)
WU_ID	Work Unit ID (USGS)
XML	Extensible Markup Language

Project Summary

MSJV was awarded the 140G0223F0145-MN_RiverWest_B23 Task Order by the United States Geologic Survey (USGS) to provide a spring 2023 leaf-off and snow-free lidar survey over an Area of Interest (AOI) of approximately 8,928.58 square miles in the State of Minnesota. This Task Order will support the 3DEP mission, the Natural Resources Conservation Service (NRCS) high-resolution elevation enterprise, as well as many state and local agencies.

The lidar mapping requirements and deliverables meet or exceed an enhanced Quality Level One (QL1) standard for final deliverables as outlined in the *USGS-NGP Lidar Base Specification 2022, Revision A* (<https://www.usgs.gov/ngp-standards-and-specifications/lidar-base-specification-online>). The Quality Level One (QL1) lidar specifications suggest a pulse density of greater than or equal to eight pulses per square meter ($\geq 8\text{ppsm}$) Aggregate Nominal Pulse Density (ANPD), and pulse spacing of less than or equal to thirty-five centimeters ($\leq 0.35\text{m}$) Aggregate Nominal Pulse Spacing (ANPS).

The vertical accuracy requirements of the lidar data meets or exceeds the following:

Absolute Vertical Accuracy

- $\leq 10\text{cm}$ RMSE_z
- $\leq 19.6\text{cm}$ Non-vegetated Vertical Accuracy (NVA) at the 95% confidence level
- $\leq 30\text{cm}$ Vegetated Vertical Accuracy (VVA) at the 95% percentile

Relative Vertical Accuracy

- $\leq 6\text{cm}$ within individual swaths (smooth surface repeatability)
- $\leq 8\text{cm}$ RMSD_z within swath overlap (between adjacent swaths)

The lidar data set was produced to meet ASPRS "Positional Accuracy Standards for Digital Geospatial Data" (2014) for a 22.5 (cm) RMSE_x / RMSE_y Horizontal Accuracy Class which equates to Positional Horizontal Accuracy = +/- 55.1 cm at a 95% confidence level.

Task Order CRS (Coordinate Reference System)

- Projection – Universal Transverse Mercator (UTM), Zone 15 North (15N)
- Horizontal Datum - North American Datum of 1983 (NAD 83), National Adjustment of 2011 (NA2011) (epoch 2010.00)
- Vertical Datum – North American Vertical Datum of 1988 (NAVD 88); using the latest NGS-approved geoid (i.e., **GEOID18**) for converting ellipsoid heights to orthometric elevations
- Horizontal Units – Meters
- Vertical Units – Meters
- EPSG Code: 6344

CONTACT INFORMATION

Questions regarding this report should be addressed to:

Doug Jacoby, CMS, GISP
Program Manager

Merrick-Surdex Joint Venture, LLP

5970 Greenwood Plaza Blvd.
Greenwood Village, CO 80111

T: +1 303-353-3903

Doug.jacoby@Merrick.com

Project Report

The contents of this report summarize the methods used to calibrate and classify the lidar data as well as the results of these methods for the 140G0223F0145-MN_RiverWest_B23 Task Order, otherwise known as PRJ_ID: 300079. Results of this report are given for the delineated WU_ID: 300408.

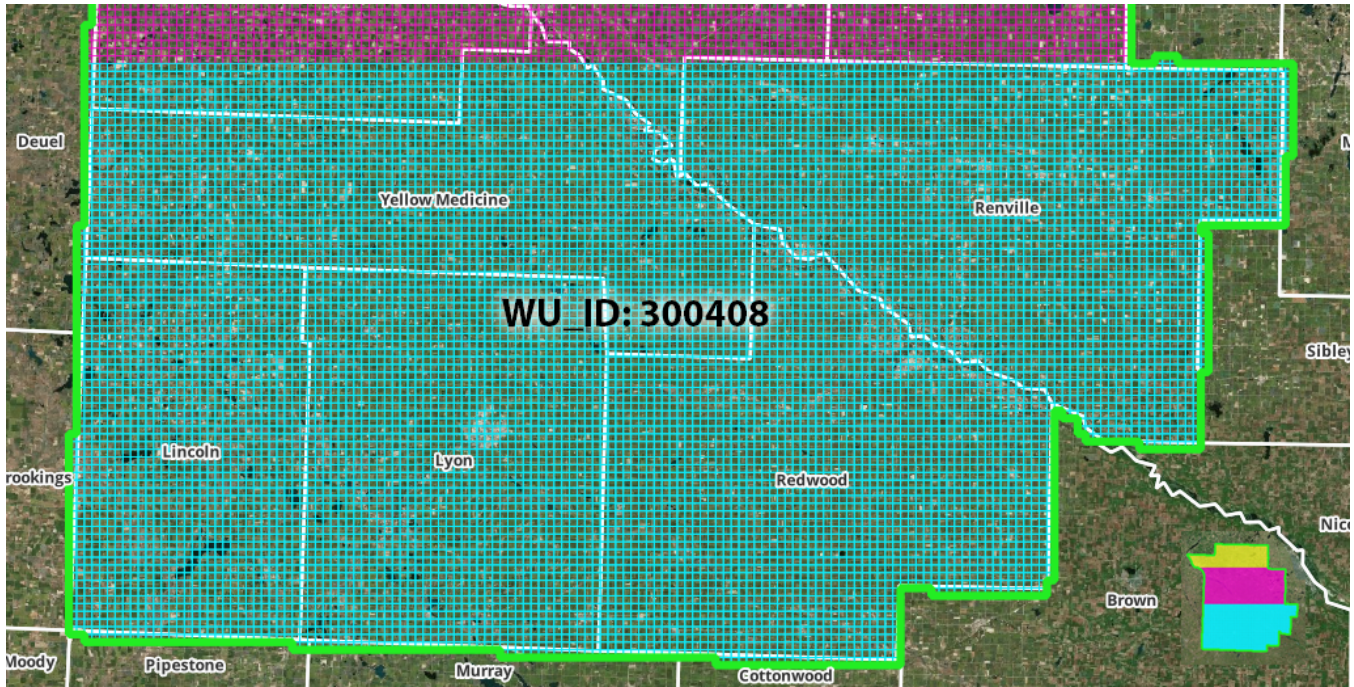

Lidar Flight Information

The acquisition area or Defined Project Area (DPA) for the 140G0223F0145-MN_RiverWest_B23 Task Order originated from the client-provided Esri shapefile (*MN_RiverWest_B23_DPA*). MSJV acquired the QL1 lidar point cloud utilizing multiple Optech Galaxy T2000 lidar sensors.

The following illustration represents the proposed (preliminary) lidar flight plan:

Aerial Mission(s)

Lidar acquisition was collected using fixed wing aircraft and Optech Galaxy T2000 lidar sensors staging from a variety of airports around the project area. Up to eight return values are recorded for each pulse which ensures the greatest chance of ground returns in a heavily forested area. Lidar data collection for WU_ID: 300408 was accomplished between May 4, 2023, and June 20, 2023 (dates listed are in local time - NOT UTC). Each mission represents a lift of the aircraft and system from the ground, collects data, and lands again. Multiple lifts within a day are represented by Mission A, B, C, and D. The table below relates each mission to the date collected, the sensor and serial number used, and the actual average MSL in meters.

Mission(s)	Date	Sensor S/N	Actual Avg. MSL (m)
230504_A	May 4, 2023	5060492	2300
230507_A	May 7, 2023	5060492	2280
230508_A	May 8, 2023	5060492	2285
230508_B	May 8, 2023	5060492	2280
230510_A	May 10, 2023	5060492	2290
230515_A	May 15, 2023	5060495	2200
230515_A	May 15, 2023	5060492	2300
230516_A	May 16, 2023	5060475	2230
230516_B	May 16, 2023	5060475	2255
230516_A	May 16, 2023	5060495	2210
230516_B	May 16, 2023	5060495	2205
230516_A	May 16, 2023	5060492	2300
230517_A	May 17, 2023	5060475	2260
230520_B	May 20, 2023	5060475	2250
230520_A	May 20, 2023	5060492	2310
230520_B	May 20, 2023	5060492	2320
230521_A	May 21, 2023	5060475	2250
230521_B	May 21, 2023	5060475	2250
230522_A	May 22, 2023	5060492	2340
230522_B	May 22, 2023	5060492	2335
230523_A	May 23, 2023	5060492	2340
230524_A	May 24, 2023	5060492	2335
230526_A	May 26,2023	5060492	2385
230526_B	May 26,2023	5060492	2385
230527_B	May 27,2023	5060492	2335
230527_A	May 27, 2023	5060475	2245
230527_B	May 27, 2023	5060475	2250
230609_A	June 9, 2023	5060492	2260
230609_B	June 9, 2023	5060492	2440
230619_A	June 19, 2023	5060475	2250

230619_B	June 19, 2023	5060475	2260
230620_A	June 20, 2023	5060475	2270
230620_B	June 20, 2023	5060475	2342

GNSS / IMU Data

A five-minute IMU initialization is conducted on the ground, with the aircraft engines running, prior to flight, to establish fine alignment of the IMU. In air IMU calibration maneuvers were performed at the beginning and ending of all mission collections to ensure the best forward and reverse trajectory processing using the highest quality IMU calibration. During the data collection, the operator recorded information on log sheets which includes weather conditions, lidar operation parameters, and flight line statistics. Data is sent back to the main office for preliminary processing to check overall quality of GNSS / IMU data and to ensure sufficient overlap between flight lines. Any problematic data may be reflown immediately as required.

The airborne GNSS data was post-processed using Applanix POSPac Mobile Mapping Suite version 8.x. A fixed-bias carrier phase solution was computed in both the forward and reverse chronological directions. Whenever practical, lidar acquisition was limited to periods when the PDOP was less than 4.0. PDOP indicates satellite geometry relating to position. Generally, PDOP's of 3.0 or less result in a good quality solution, however PDOP's between 3.0 and 5.0 can still yield good results most of the time. PDOP's over 6.0 are of questionable results and PDOP's of over 7.0 usually result in a poor solution. Usually as the number of satellites increase the PDOP decreases. Other quality control checks used for the GNSS include analyzing the combined separation of the forward and reverse GNSS processing from one CORS station and the results of the combined separation when processed from two different CORS stations. An analysis of the number of satellites, present during the flight and data collection times, is also performed.

The GNSS trajectory was combined with the raw IMU data and post-processed using POSPac Mobile Mapping Suite version 8.x. The SBET and refined attitude data are then utilized in the Optech LMS lidar processing software to compute the laser point-positions. The trajectory is combined with the laser range measurements to produce lidar point cloud data.

POS reports for each mission are included on the delivery media: ..\metadata\reports\Lidar_Report\POS_reports

GNSS Controls

Virtual Ground GNSS Base Station(s) were used to control the lidar airborne flight lines. Post processed Trimble CenterPoint® RTX™ correction service is a high-accuracy, satellite-delivered global positioning service. This technology provides high accuracy GNSS positioning without the use of traditional reference station based differential RTK infrastructure and delivers very high cm level accuracy. In addition, CORS are at times used to further QC or enhance the airborne GNSS solution.

Acquisition Data Check

Validation of field data is a time-critical process. Since re-mobilizations have significant financial and schedule impacts, the JV's goal for every project is to ensure that all data has been completely and accurately acquired before leaving the project site. While coverage is one aspect to verify, MSJV team focuses on checking aspects that prove adherence to all lidar base specification requirements as well as a full data integrity check. Using the MARS® QC Module, the following tests are performed on each mission:

Test	Methodology	Purpose
------	-------------	---------

Returns	Tabular stats and graphics	To ensure all return collecting system components are working properly.
Intensity	Tabular stats and graphics	To ensure all intensity collecting system components are working properly. Also, to look for potential, but rare, laser return path misalignment system issues.
Density	Density calculations by swath but also by spot location, binary raster, density raster, project aggregate, and Voronoi density reporting	To ensure the minimum required lidar point density is achieved for every flight line.
Data Void	Binary raster method as required by LBS	To ensure no unallowable data voids are present
Spatial Distribution	Binary raster method as required by LBS	To ensure all swaths have been collected with the appropriate spatial distribution requirement
Relative Accuracy	Flightline separation raster	An initial look at interswath accuracy, prior to full calibration, to ensure there are no severe and unexpected calibration issues
Sensor Calibration	Scan direction 1 vs 2 separation raster and channel to channel separation raster if applicable	An initial look at intraswath accuracy, prior to full calibration, to ensure there are no severe and unexpected calibration issues
Flight Line Coverage	Coverage rasters	To ensure full coverage of the project boundary. This is a second but different look for data voids.
Sensor Anomalies	Shaded relief raster	To ensure there are no sensor anomalies visible in a shaded relief raster

Lidar Calibration – see appendix 1 for a more detailed workflow description

MSJV takes great care to ensure all lidar acquisition missions are carried out in a manner conducive to post-processing an accurate dataset. Proper Airborne GNSS surveying techniques are always followed including pre- and post-mission static initializations. In-air IMU alignments (figure-eights) are performed both before and after on-site collection to ensure proper calibration of the IMU accelerometers and gyros.

A minimum of one cross-flight is planned throughout the project area across all flightlines and over roadways where possible. The cross-flight provides a common control surface used to remove any vertical discrepancies in the lidar data between flightlines. The cross-flight is critical to ensure flightline ties across the project area. The areas of overlap between flightlines are used to boresight (calibrate) the lidar point cloud to achieve proper flightline to flightline alignment in all three axes. Each lidar mission flown is accompanied by a hands-on boresight in the office.

MSJV understands that high accuracy/quality data cannot be generated from black-boxed-processed lidar data. Many parts of the downstream process suffer from poorly calibrated lidar data. We have a proven process that produces data that can meet relative and absolute accuracy specifications reserved for QL0 data for all quality level products (should the ground control support such). Our all-encompassing lidar calibration process includes the following steps:

1. Sensor model calibration (scale, edge curl, range offsets, etc.)
2. Application of timing offsets (POS and scanner)
3. Calibrating scan direction 0 versus scan direction 1 (inbound versus outbound if applicable)
4. IMU to scanner misalignment angles (heading, pitch, roll deltas) calibration
5. Final geometric calibration tweaks including:
 - a. easting, northing, elevation shifts
 - b. heading, roll, pitch shifts
 - c. easting, northing, elevations drifts

- d. heading, roll, pitch drifts
- e. fluctuating elevation

Below is an example of before (left) and after (right) flightline separation rasters (FSR) having been through this highly effective process. The remaining non-green colors are areas of steep terrain.

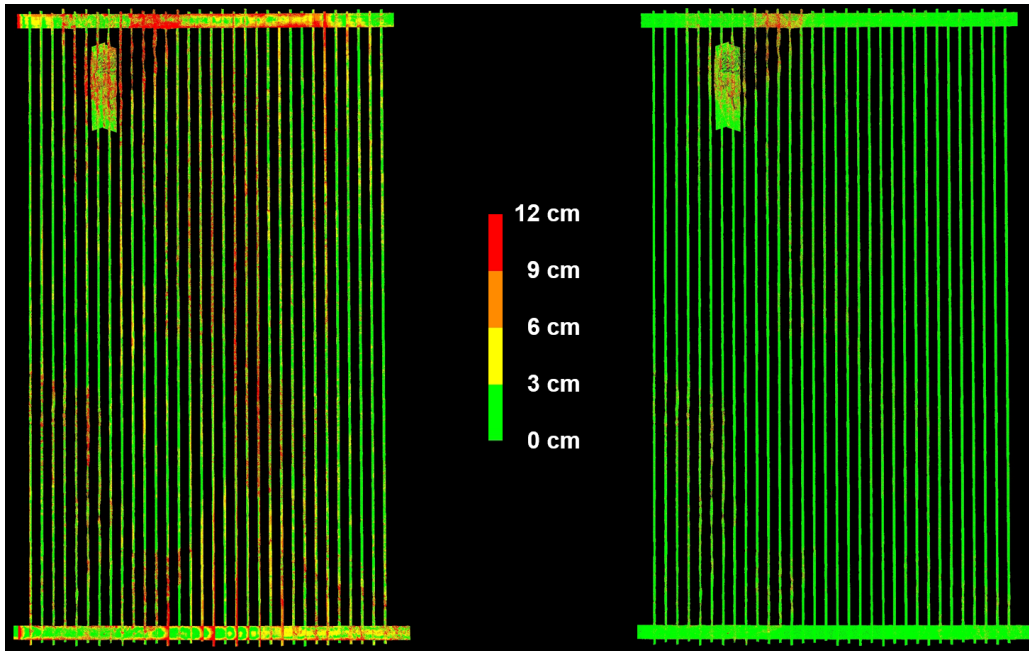

Project wide results are equally as accurate.

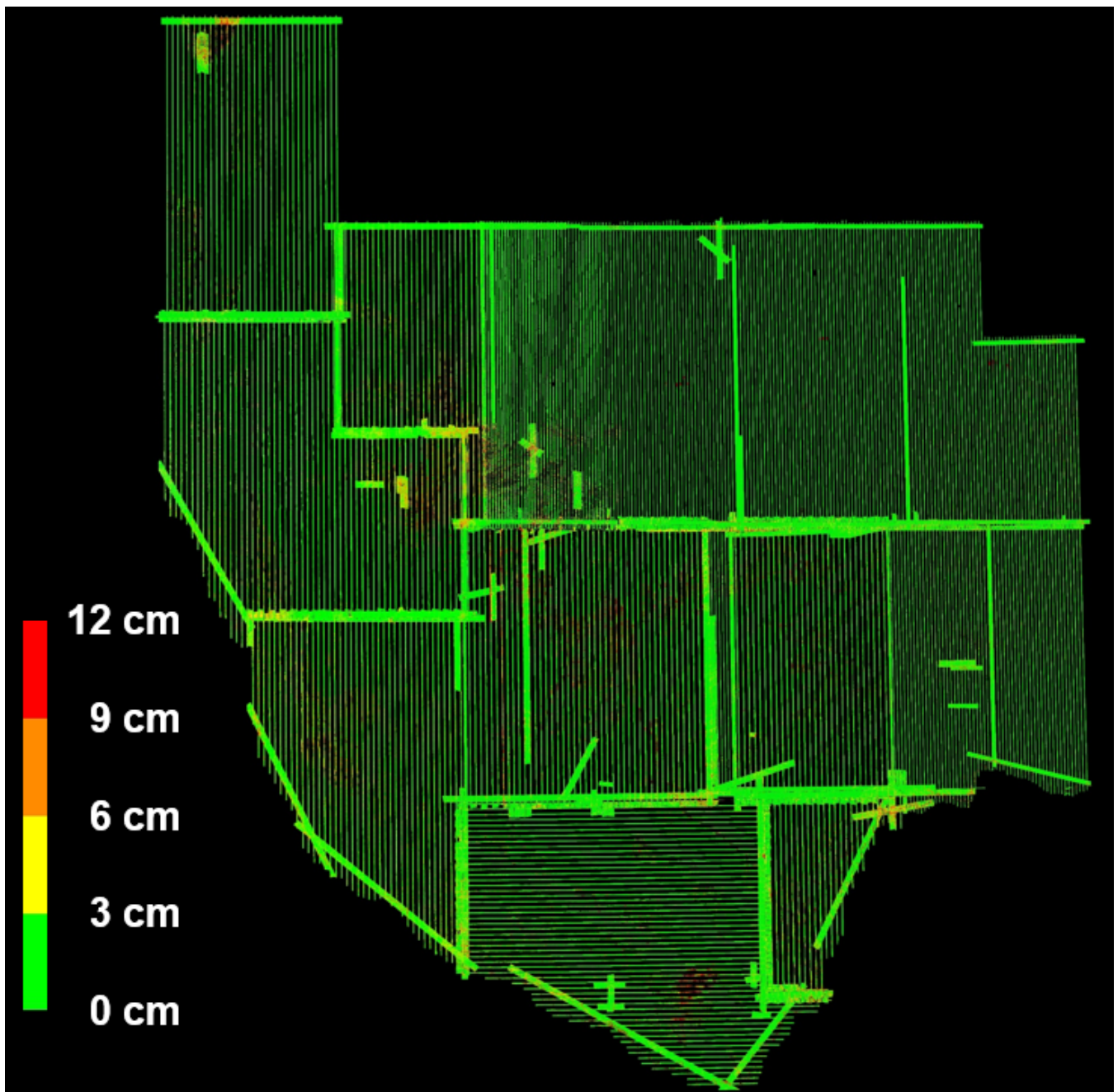

After boresighting is complete a detailed statistical report is generated to check relative and absolute accuracies before filtering of lidar begins. The calibration process yields excellent absolute accuracies, as can be seen for this example project.

MARS Check Point Report

Inputs Check point file: Y:\Mapping\Projects\65220171_USGS-TX_West_Texas\Survey_Control\02_Laser_Control\TX_West_Surdex_Portion_CAL_nad2011_utm13_12b_meters.csv

Requirement	USGS LBS 1.2 Quality Level	Vertical Accuracy Class	RMSEz Non-Vegetated for TIN/DEM (cm)	NVA at 95% Confidence Level for TIN/DEM (cm)	VVA at 95th Percentile for TIN/DEM (cm)	Equivalent Class 1 Contour Interval per ASPRS 1990 (cm)	Equivalent Class 2 Contour Interval per ASPRS 1990 (cm)	Equivalent Contour Interval per NMAS (cm)
<input type="checkbox"/>		1.0-cm	1.0	2.1	3	3.0	1.5	3.29
<input type="checkbox"/>		2.5-cm	2.5	4.9	7.5	7.5	3.8	8.22
<input type="checkbox"/>	QL0	5.0-cm	5.0	9.8	15	15.0	7.5	16.45
<input type="checkbox"/>	QL1	10.0-cm	10.0	19.6	30	30.0	15.0	32.90
<input checked="" type="checkbox"/>	QL2	10.0-cm	10.0	19.6	30	30.0	15.0	32.90
<input type="checkbox"/>		15.0-cm	15.0	29.4	45	45.0	22.5	49.35
<input type="checkbox"/>	QL3	20.0-cm	20.0	39.2	60	60.0	30.0	65.80
<input type="checkbox"/>		33.3-cm	33.3	65.3	100	99.9	50.0	109.55
<input type="checkbox"/>		66.7-cm	66.7	130.7	200	200.1	100.1	219.43
<input type="checkbox"/>		100.0-cm	100.0	196.0	300	300.0	150.0	328.98
<input type="checkbox"/>		333.3-cm	333.3	653.3	1000	999.9	500.0	1096.49

Elevation Calculation Method
 TIN Grid

Search Radius for 3 points (TIN) - default value is 5x the calculated GSD

Classifications Included

LAS Files - Count: 656

Display LAS file path

Statistics for NVA Points of Project (in data units)
 Check Points Points with Coverage NVA Points VVA Points

Average Vertical Error

Maximum Vertical Error Median Vertical Error Minimum Vertical Error

Standard Deviation of Vertical Error

Skewness of Vertical Error The distribution is considered symmetrical if skewness is close to zero [between -0.5 and 0.5] and the mean is nearly equal to the median.

Kurtosis of Vertical Error The distribution is considered normal if the kurtosis is between -3 and 3.

Standards

	TIN	DEM
Non-vegetated Vertical Accuracy (NVA) RMSEz (cm)	<input type="text" value="4.693"/>	<input type="text" value="5.015"/>
Non-vegetated Vertical Accuracy (NVA) at the 95% Confidence Level (cm) +/-	<input type="text" value="9.199"/>	<input type="text" value="9.829"/>
Vegetated Vertical Accuracy (VVA) at the 95th Percentile (cm) +/-	<input type="text"/>	<input type="text"/>
FGDC/NSSDA Vertical Accuracy at the 95% Confidence Level (cm) +/-	<input type="text" value="9.199"/>	<input type="text"/>

This data set was tested to meet ASPRS Positional Accuracy Standard for Digital Geospatial Data (2014) for a 10.0-cm RMSEz Vertical Accuracy Class. Actual NVA accuracy was found to be RMSEz = 4.693cm, equating to +/- 9.199cm at the 95% confidence level.

Data Units: **Meter**

Relative Accuracy – flight line to flight line

The purpose of the SSIs is to show graphics of two distinct flight line separation rasters for all of the data processed - a Swath Separation Image (SSIs) raster. These images show the vertical separation of flight lines by thematically coloring the separation magnitude on a color ramp based on absolute distance. This color thematic rendering is modulated by intensity to show land cover features. Color-coded elevation difference rasters of the overlap areas are created for review, all returns are used, and no cut-off is applied to the maximum elevation difference shown. The table shown here is from the USGS NGP Lidar Base Specification document - it lists the allowable 'Swath overlap difference, RMSDz' values (in meters) for the four defined Quality Levels:

Quality level	Smooth surface repeatability, RMSD _z (m)	Swath overlap difference, RMSD _z , (m)
QL0	≤0.03	≤0.04
QL1	≤0.06	≤0.08
QL2	≤0.06	≤0.08
QL3	≤0.12	≤0.16

The project representative flight line separation raster (below) depicts the vertical separation of flight lines by thematically coloring the separation magnitude on a color ramp based on relative distance. The surface interpolation method used in producing the swath separation image(s) (SSIs) for this WU was a grid method set to 1m cell size. Grid method was used instead of the typical TIN method due to overlapping areas of patch lines causing false positives where the TIN triangles created were too large for accurate representation of the ground.

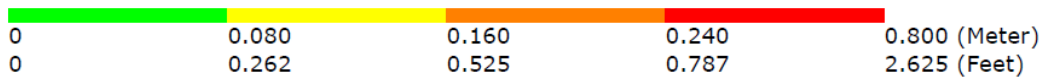
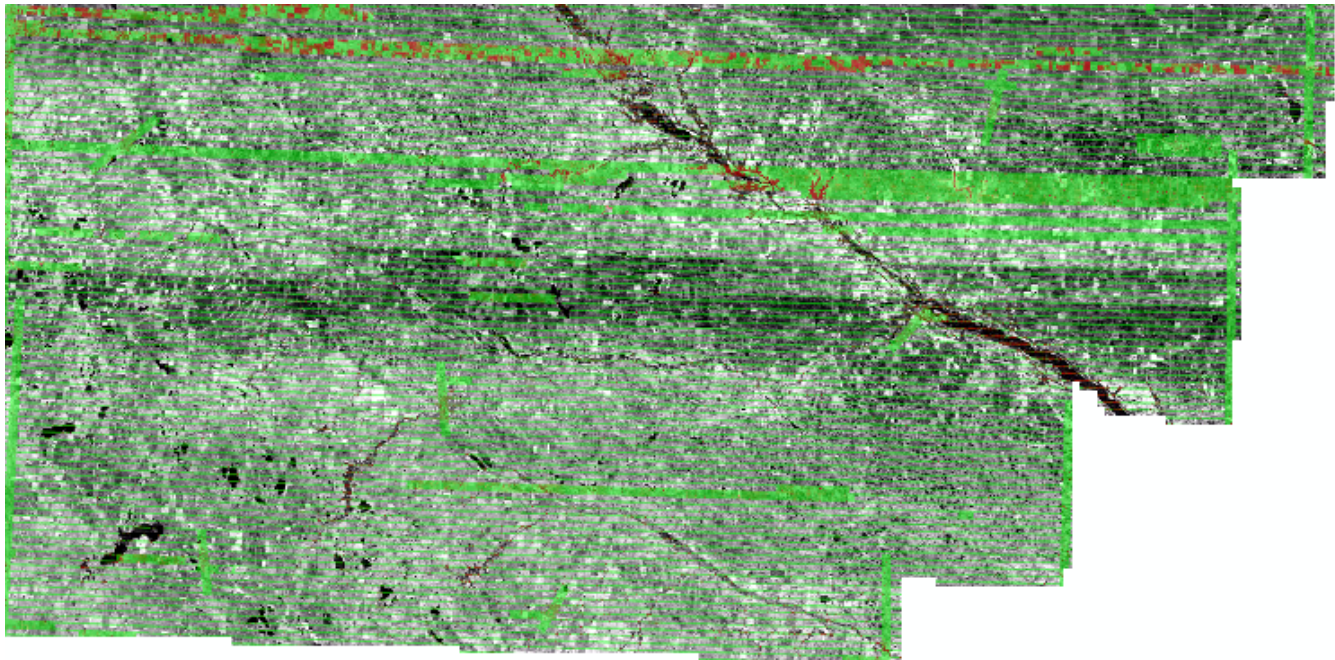

Smooth Surface Precision (intraswath)

The purpose of this section is to evaluate smooth surface repeatability / intraswath precision by measuring departures from planarity of single returns from hard planar surfaces, normalizing for actual variation in the

surface elevation. Repeatability of clusters of single returns is then assessed at multiple locations within hard surfaced areas (for example, parking lots or large rooftops).

Assessment is made on hard surfaced areas (for example, parking lots or large rooftops) containing only single return lidar points. Sample areas for assessment of precision are approximately 100 pixels. To the degree allowed by the data and the project environment, multiple sample areas representing the full width of the swath(s) (left, center, and right) will be examined. Multiple single swaths from a single lift may be used if needed to sample the full swath width. At a minimum, precision shall be assessed against for each lift of each aircraft/instrument combination used on the project. Each test area will be evaluated using a signed difference raster with a cell size equal to the ANPS, rounded up to the next integer, then doubled (Cellsize=CEILING(ANPS)×2). The difference rasters are statistically summarized to verify that root mean square difference in the z direction (RMSDz) values do not exceed the limits set forth in table 2 for the QL of information that is being collected. These rasters are included on the delivery media: ..\
metadata\spatial_metadata\contractor_provided\MN_West_B3_QC\DPH_8

Unfiltered Lidar Control Point Report

The following statistical results of the lidar data compared to the lidar control points post-calibration. The results show the difference between the lidar points and the 98 surveyed ground control points located in PRJ_ID: 300079.

Project Data Unit: Meter
Vertical Accuracy Class tested: 10.0-cm
Elevation Calculation Method: Interpolated from TIN
LiDAR Classifications Included: 0-255

Check Points in Report: 98
Check Points with LiDAR Coverage: 98
Check Points (NVA): 98
Check Points (VVA): 0
Average Vertical Error Reported: 0.000 Meter
Maximum (highest) Vertical Error Reported: 0.16 Meter
Median Vertical Error Reported: -0.003 Meter
Minimum (lowest) Vertical Error Reported: -0.147 Meter
Standard deviation of Vertical Error: 0.046 Meter
Skewness of Vertical Error: 0.257
Kurtosis of Vertical Error: 1.608
Non-vegetated Vertical Accuracy (NVA) RMSE(z): 4.565cm PASS
Non-vegetated Vertical Accuracy (NVA) at the 95% Confidence Level +/-: 8.947cm PASS
FGDC/NSSDA Vertical Accuracy at the 95% Confidence Level +/-: 8.947cm
Non-vegetated Vertical Accuracy (NVA) RMSE(z) (DEM): 4.848cm PASS
Non-vegetated Vertical Accuracy (NVA) at the 95% Confidence Level +/- (DEM): 9.501cm PASS

This data set was tested to meet ASPRS Positional Accuracy Standard for Digital Geospatial Data (2014) for a 10.0-cm RMSEz Vertical Accuracy Class. Actual NVA accuracy was found to be RMSEz = 4.565cm, equating to +/- 8.947cm at the 95% confidence level.

Lidar Control Point Layout

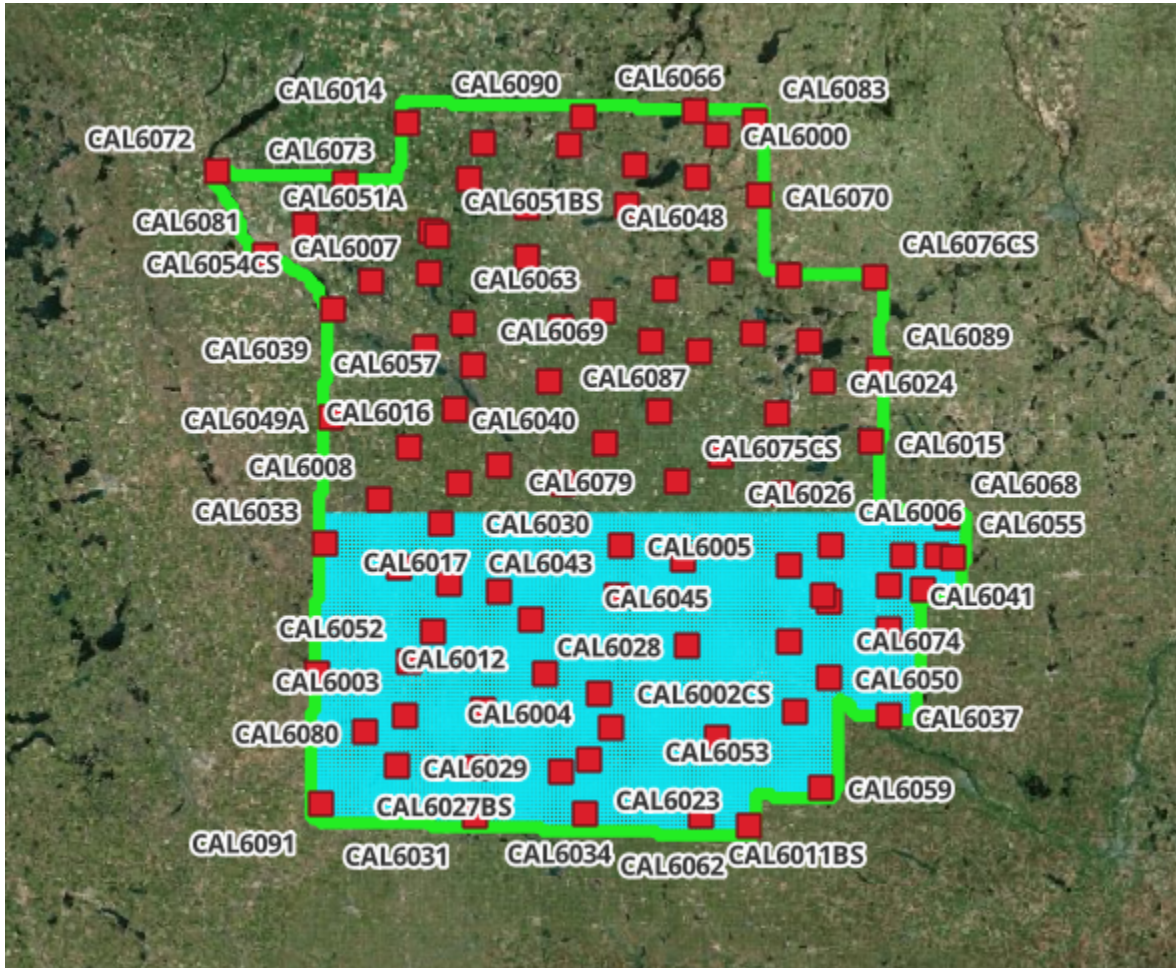

Lidar Filtering and Classification

The lidar filtering process encompasses a series of automated and manual steps to classify the boresighted point cloud data set. Each project represents unique characteristics in terms of cultural features (urbanized vs. rural areas), terrain type and vegetation coverage. These characteristics are thoroughly evaluated at the onset of the project to ensure that the appropriate automated filters are applied and that subsequent manual filtering yields correctly classified data. Data is most often classified by ground and “unclassified”, but specific project applications can include a wide variety of classifications including but not limited to buildings, vegetation, power lines, etc. A variety of software packages are used for the auto-filtering, manual filtering, and QC of the classified data.

MSJV used the ASPRS LAS Specification Version 1.4 – R15 (ASPRS, 2011, published 09 July 2019), Point Data Record Format 6 for this project and classified the lidar point cloud in accordance with the following classification classes and bitflags. The following outlines project specific requirements.

- Class 1 = Unclassified
- Class 2 = Bare-earth Ground
- Class 7 = Low point (noise)
- Class 9 = Water
- Class 17 = Bridge decks
- Class 18 = High noise

- Class 20 = Ignored Ground (breakline proximity)
- Class 21 = Snow (if present and identifiable)
- Class 22 = Temporal exclusion (typically non-favored data in intertidal zones)
- Bitflags
 - Withheld: Within the LAS file specification, a single bit flag indicating that the associated lidar point is geometrically anomalous or unreliable and should be ignored for all normal processes. These points are identified using a series of point filtering macros.
- Synthetic Points: Optech’s Galaxy T2000 raw lidar post-processing software LMS uses a method to fill small voids with synthetic points when the PulseTRAK™ algorithm drops a point recording. This can happen between the transition of PIA (pulse-in-air) zones.

MSJV has developed several customized automated filters that are applied to the lidar data set based on project specifications, terrain, and vegetation characteristics. A filtering macro, which may contain one or more filtering algorithms, is executed to derive LAS files separated into the different classification groups as defined in the ASPRS classification table. The macros are tested in several portions of the project area to verify the appropriateness of the filters. Often, there is a combination of several filter macros that optimize the filtering based on the unique characteristics of the project. Automatic filtering generally yields a ground surface that is 85-90% valid, so additional editing (hand-filtering) is required to produce an accurate ground surface.

Lidar data is next taken into a graphic environment using MARS® to manually re-classify (or hand-filter) “noise” and other features that may remain in the ground classification after auto filter. A cross-section of the post auto-filtered surface is viewed to assist in the reclassification of non-ground data artifacts. The following is an example of re-classification of the non-ground points (elevated features) that need to be excluded from the true ground surface. Certain features such as berms, hilltops, cliffs and other features may have been aggressively auto-filtered and points will need to be re-classified into the ground classification. Data in the profile view displays non-ground (Unclassified, class 1) in grey and ground in brown/tan (Class 2). In **Figure 1**, a small building was not auto-filtered and needs to be manually re-classified. Note that **Figure 2** has the building points reclassified to unclassified from the true ground surface.

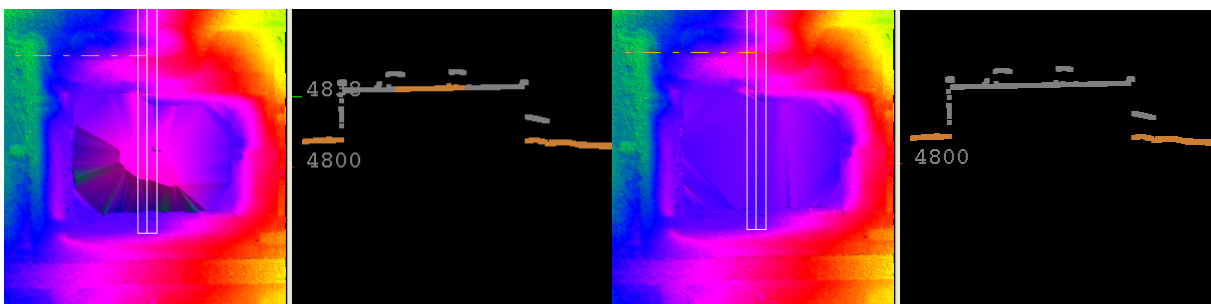

Figure 1

Figure 2

A combination of automated and semi-automated routines to classify buildings and vegetation. We expect that the classified buildings will meet expected filtering criteria.

At this point, individual lidar points from the original point cloud have now been parsed into separate classifications.

Filtered Lidar Checkpoint Report

After hand-filtering has been completed and quality checked, a Checkpoint Report is generated to validate that the accuracy of the ground surface is within the defined accuracy specifications. Each surveyed ground check point is compared to the lidar surface by interpolating an elevation from a Triangulated Irregular Network (TIN) of the surface. The MARS® derived report provides an in-depth statistical report, including an RMSE of the vertical errors; a primary component in most accuracy standards and a statistically valid assessment of the overall accuracy of the ground surface.

The below lidar check point reports provide statistics for 159 ground survey checkpoints used to validate the final filtered lidar surface.

Units: Meter (/Feet)

Vertical Accuracy Class tested: 10-cm

Check Points in defined project area (DPA):	159
Check Points with Lidar Coverage	159
Check Points with Lidar Coverage (NVA)	83
Check Points with Lidar Coverage (VVA)	76
Average Z Error (NVA)	-0.008/-0.027
Maximum Z Error (NVA)	0.176/0.577
Median Z Error (NVA)	-0.009/-0.031
Minimum Z Error (NVA)	-0.097/-0.318
Standard deviation of Vertical Error (NVA)	0.039/0.128
Skewness of Vertical Error (NVA)	1.228
Kurtosis of Vertical Error (NVA)	4.493
Non-vegetated Vertical Accuracy (NVA) RMSE(z) ¹	0.040/0.130 PASS
Non-vegetated Vertical Accuracy (NVA) at the 95% Confidence Level +/- ¹	0.078/0.255 PASS
FGDC/NSSDA Vertical Accuracy at the 95% Confidence Level +/-	0.078/0.255
Non-vegetated Vertical Accuracy (NVA) RMSE(z) (DEM) ²	0.039/0.127 PASS
Non-vegetated Vertical Accuracy (NVA) at the 95% Confidence Level (DEM) +/- ²	0.076/0.249 PASS
Vegetated Vertical Accuracy (VVA) at the 95th Percentile (TIN) +/- ¹	0.124/0.407 PASS
Vegetated Vertical Accuracy (VVA) at the 95th Percentile (DEM) +/- ²	0.140/0.460 PASS

This data set was tested to meet ASPRS Positional Accuracy Standard for Digital Geospatial Data (2014) for a 10-cm RMSEz Vertical Accuracy Class. Actual NVA accuracy was found to be RMSEz = 4.0cm, equating to +/- 7.8cm at the 95% confidence level. Actual VVA accuracy was found to be +/- 14.0cm at the 95th percentile.

¹ This value is calculated from TIN-based testing of the lidar point cloud data.

² This value is calculated from RAM-based grid testing of the lidar data. The grid cells are sized according to the Quality Level selected, and are defined in the USGS NGP Lidar Base Specification 2023 rev. A (Table 6).

Lidar Checkpoint Layout

- ▲ NVA
- WVA

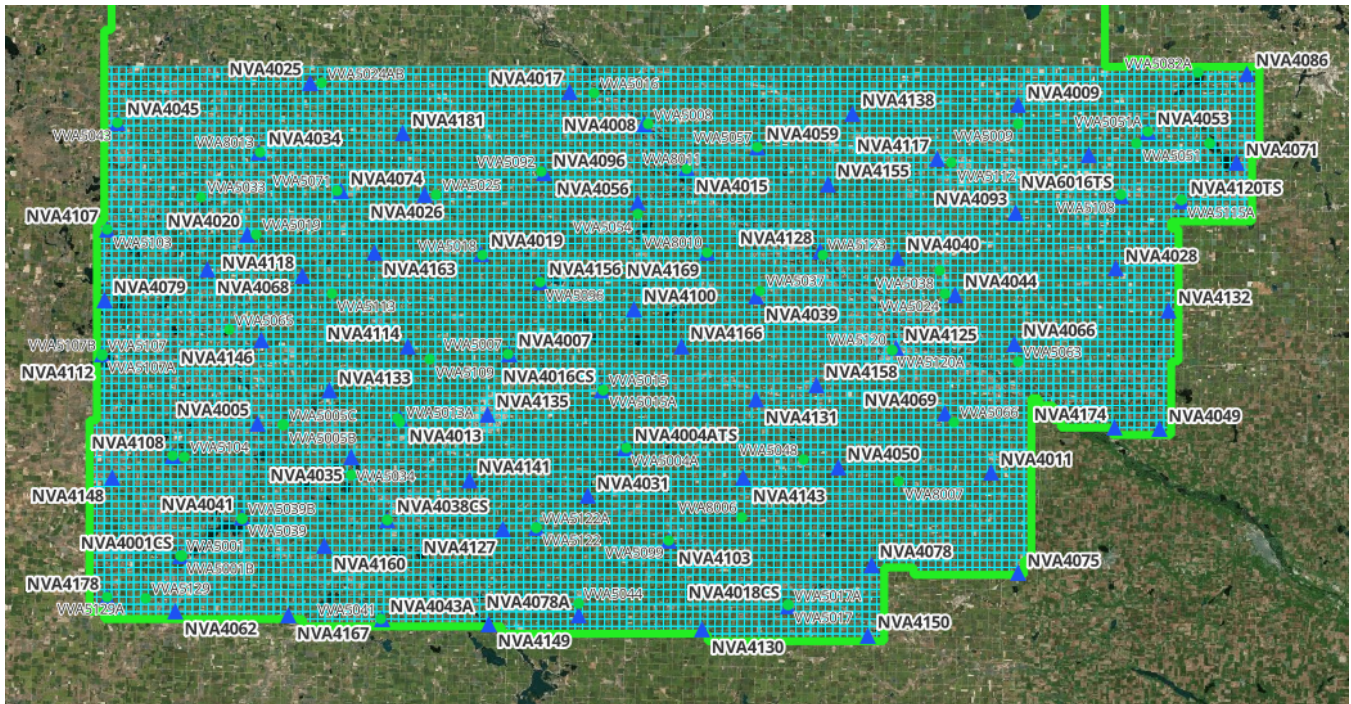

Hydro-flattening Breakline Collection

Hydro- flattening breaklines are captured per the *USGS-NGP Lidar Base Specification 2022, Revision A*. Final hydro-flattened breaklines features are appropriately turned into polygons (flat elevations) and polylines (decreasing by elevation) and are used to reclassify ground points in water to water (Class 9). The lidar points around the breaklines are reclassified to ignored ground (Class 20) based on the planned collected point density.

The next step in the process is the hydro-flattening breakline collection required for the development of the hydro-flattened DEMs. MSJV captures hydro-flattening breaklines for waterbodies greater than or equal to approximately eight-tenths (~0.8) hectare (e.g., ~100-meter diameter); double-sided streams and rivers that are greater than or equal to thirty-meters ($\geq 30\text{m}$) in (nominal) width, and; any visible islands greater than or equal to approximately four-tenths (~0.4) hectare. Criteria for *Non-Tidal Boundary Waters* and *Tidal Waters* are assumed not applicable. No single-line streams or drainages will be collected, nor will any planimetric features that could be utilized as traditional breaklines. All downstream hydro-flattening breaklines require monotonicity (e.g., streams and rivers). Closed polygonal boundaries of water will maintain a fixed (i.e., flat) elevation.

Linear hydrographic features

To collect hydrographic features, MSJV uses a methodology that directly interacts with the lidar bare-earth data to collect drainage breaklines. To determine the alignment of a drainageway, the technician first views the area as a TIN of bare-earth points using a color ramp to depict varying elevations. In areas of extremely flat terrain, the technician may need to determine the direction of flow based on measuring lidar bare-earth points at each end of the drain. The operator will then use the color ramped TIN to digitize the drainage in 2D with the elevation being attributed directly from the bare-earth LAS data. MARS® software has the capability of “flipping” views between the elevation TIN, intensity, and imagery, as necessary, to further assist in the determination of the drainage. All drainage breaklines are collected in a downhill direction. For each point collected, the software

uses a user specified search radius to identify the lowest point within that proximity. Within each radius, if a bare-earth point is not found that is lower than the previous point, the elevation for subsequent point remains the same as the previous point. This forces the drain to always flow in a downhill direction. Waterbodies that are embedded along a drainageway are validated to ensure consistency with the downhill direction of flow.

This methodology may differ from those of other vendors in that MSJV relies on the bare-earth data to attribute breakline elevations. As a result of our methodology, there is no mismatch between lidar bare-earth data and breaklines that might otherwise be collected in stereo 3D as a separate process. This is particularly important in densely vegetated areas where breaklines collected in 3D from imagery will most likely not match (either horizontally or vertically), the more reliable lidar bare-earth data.

MSJV has the capability of “draping” 2D breaklines to a bare-earth elevation model to attribute the “z” as opposed to the forced downhill attribution methodology described above. However, the problem with this process is the “pooling” effect or depressions along the drainageway caused by a lack of consistent penetration in densely vegetated areas.

Criteria of linear hydrographic breaklines are as follows:

- Linear hydrographic features (e.g., visible streams, rivers, shorelines, canals, etc.) greater than or equal to 30m wide (nominal width) will be captured as a double-lined polygon
 - linear hydrographic features must be flat and level bank-to-bank (perpendicular to the apparent flow centerline) with gradient following the immediately surrounding terrain
 - water surface edge must be at or just below the immediately surrounding terrain
 - streams should break at road crossings (e.g., culverts), and streams and rivers should not break at bridges

Waterbodies

Waterbodies are digitized from the color ramped TIN/Intensity, similar to the process described above. The elevation attribute is determined as the technician collects the hydro feature by using the lowest bare-earth point within a search radius of the polygon line being drawn.

Criteria of waterbody breaklines are as follows:

- Waterbodies (e.g., lakes, ponds, reservoirs) greater than or equal to approximately 0.8 hectares in size are surrounded by a water breakline (i.e., closed polygon)
 - waterbodies must be flat and level with a single elevation for every bank vertex
 - water surface edge must be at or just below the immediately surrounding terrain
 - long impoundments, such as reservoirs or inlets, whose water surface elevations drop when moving downstream should be treated as rivers

Color cycles provide a clear indication of where breaklines are to be collected, especially hydrographic breaklines. **Figure 3** demonstrates no breaklines, where **Figure 4** is breakline enforced displayed using color cycles within the MARS® software environment.

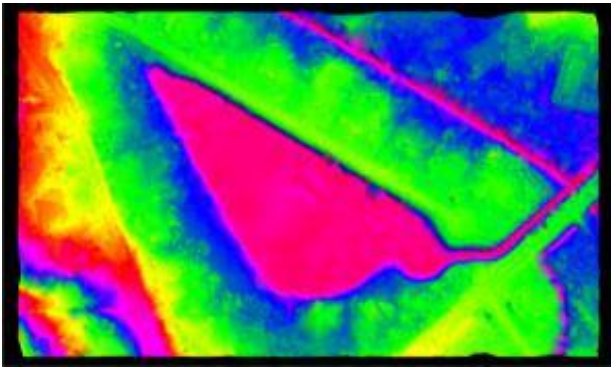

Figure 3

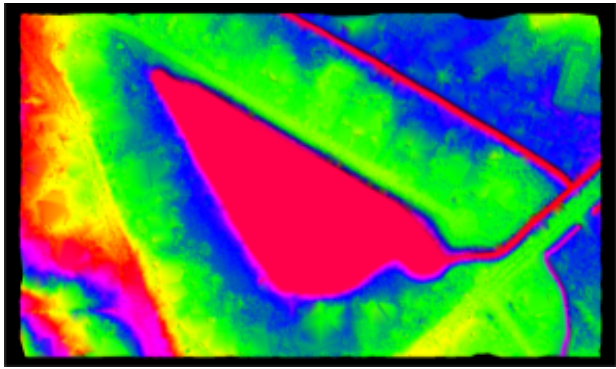

Figure 4

Bare-earth Digital Elevation Model (DEM)

MSJV exports the hydro-flattened classified ground (i.e., Class 2) lidar points to a **half meter (0.5m)**, 32-bit floating point raster images using MARS®. The DEMs are exported to the project tiling scheme, and in some cases, project- or area-wide. Projection information is applied that reflects the project CRS. Culverts will not be removed from the DEMs. Bridges will be removed from the DEMs. Breaklines containing elevation values on vertices are draped on top of the lidar and using a Triangulated Irregular Network (TIN) interpolation method, grids are generated. CRS was applied to rasters using GDAL 2.2.0.

Maximum Surface Height Raster (MSHR)

MSJV will export the first return lidar points to a **half meter (0.5m)** cell size, 32-bit floating point raster images using MARS®. The DSMs are exported to the project tiling scheme, and in some cases, project or area-wide. Projection information is applied that reflects the project CRS.

List of Deliverables

- ❖ Minimum standards as outlined in **Exhibit 1**
- ❖ Classified LiDAR point cloud
 - Fully compliant ASPRS LAS 1.4-R15, point record format 6
 - Formatted to 1,000m x 1,000m tiles
- ❖ Bare-earth DEM (Digital Elevation Model)
 - 32-bit floating point raster in Cloud Optimized GeoTIFF (COG) format (.tif)
 - Half-meter (0.5m) cell size formatted to 1,000m x 1,000m tiles
- ❖ Hydro-flattened breaklines
 - Area-wide Esri file geodatabase / feature class(es)
- ❖ Vertical Accuracy (GeoPackage format)
 - Calibration (control)
 - NVA/VVA (checkpoints)
- ❖ Esri shapefiles
 - Flight index
 - Esri file geodatabase (GDB)
 - DPA
 - Tiles (clipped to DPA)
- ❖ FGDC-compliant metadata in XML format
 - LAS
 - DEM
 - Breaklines
- ❖ MARS® QC folder
 - PDF QC reports
 - Miscellaneous files / folders
- ❖ Maximum Surface Height Raster (MSHR)
 - 32-bit floating point raster in COG format (.tif)
 - 0.5m cell size formatted to 1,000m x 1,000m tiles
- ❖ Swath Separation Image (SSI)
 - 8-bit unsigned, 3-band raster in in COG format (.tif)
 - One meter (1.0m) cell size formatted to 1,000m x 1,000m tiles
- ❖ Lidar and Mapping Report in PDF format
 - Acquisition

- Processing
- Accuracy assessment
- POS reports
- ❖ Ground Control Survey Report in PDF format
 - Acquisition
 - Processing
 - Coordinate listing (all points)
 - Photos (all points) in jpeg (JPG) format

Appendix 1

Following is a more detailed lidar calibration workflow description.

LIDAR CALIBRATION AND BLOCK LAS OUTPUT

Note: All figures represented on the following pages are for general illustration purposes, and are not examples derived from the project.

Initial Processing

Lidar data is output as LAS point data using Optech's Lidar Mapping Suite (LMS). LMS matches ground and roof planes plus roof lines to self-calibrate and correct system biases. These biases occur within the hardware of the laser scanning systems, within the Inertial Measurement Unit (IMU) and because of environmental conditions which affect the refraction of light. The systemic biases that are corrected for include scale, roll, pitch, and heading.

In addition to the self-calibration mode LMS runs a "production" mode which applies the self-calibration parameters and then analyzes each individual flight line and applies small adjustments to each line to tie overlapping lidar points even more tightly together.

Boresight Self-Calibration Processing Procedures

An LMS boresight calibration is performed on an as-needed basis to correct scale, roll, pitch and heading biases. A minimum of three overlapping flights are flown in opposing directions with one cross flight.

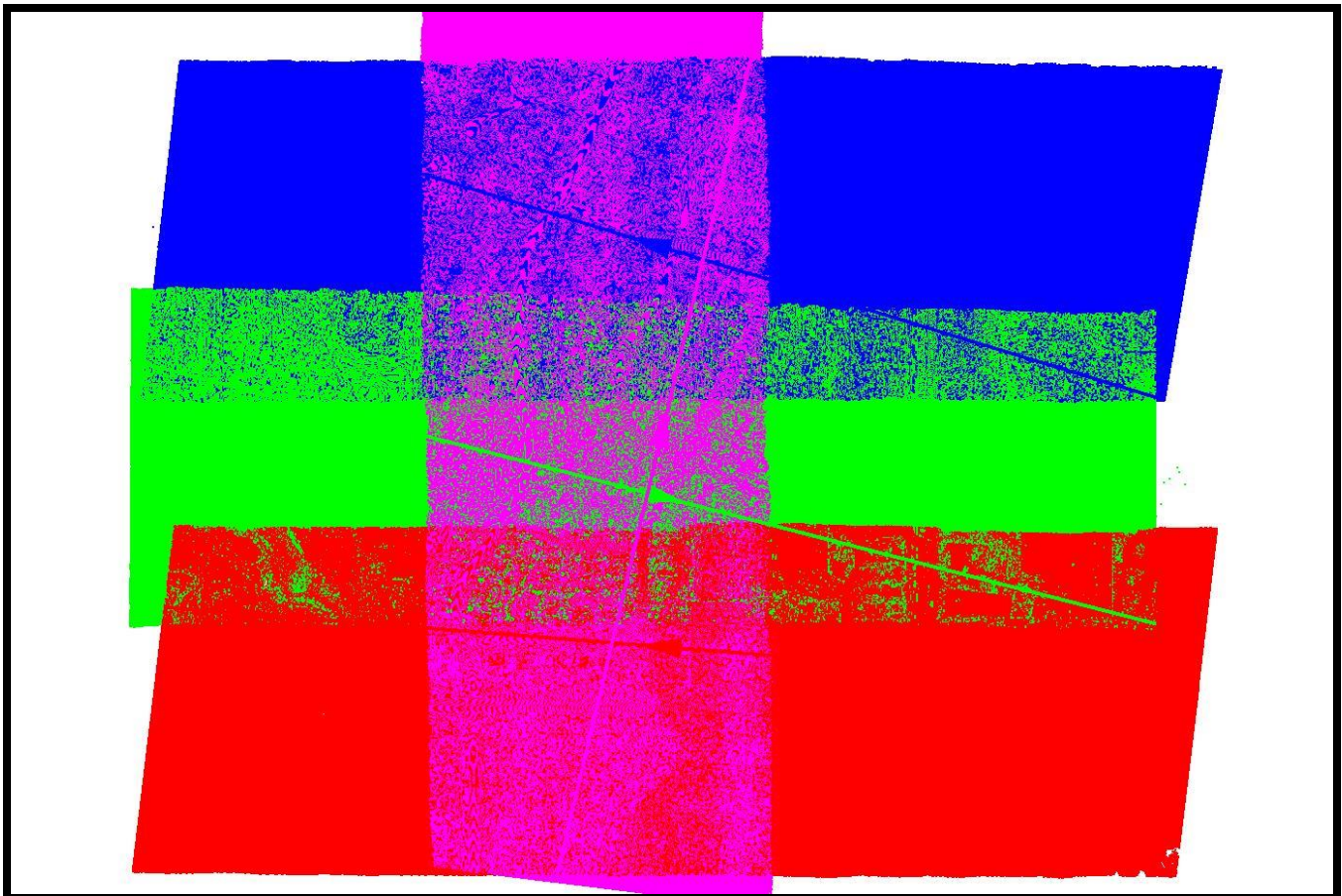

The Boresighting module frees scan angle scale, scan angle lag, XYZ boresight corrections and elevation position corrections while locking scan angle offset and XY position corrections.

The picked calibration site will have a good distribution of buildings for the self-calibration software to match ground planes, roof planes and roof lines.

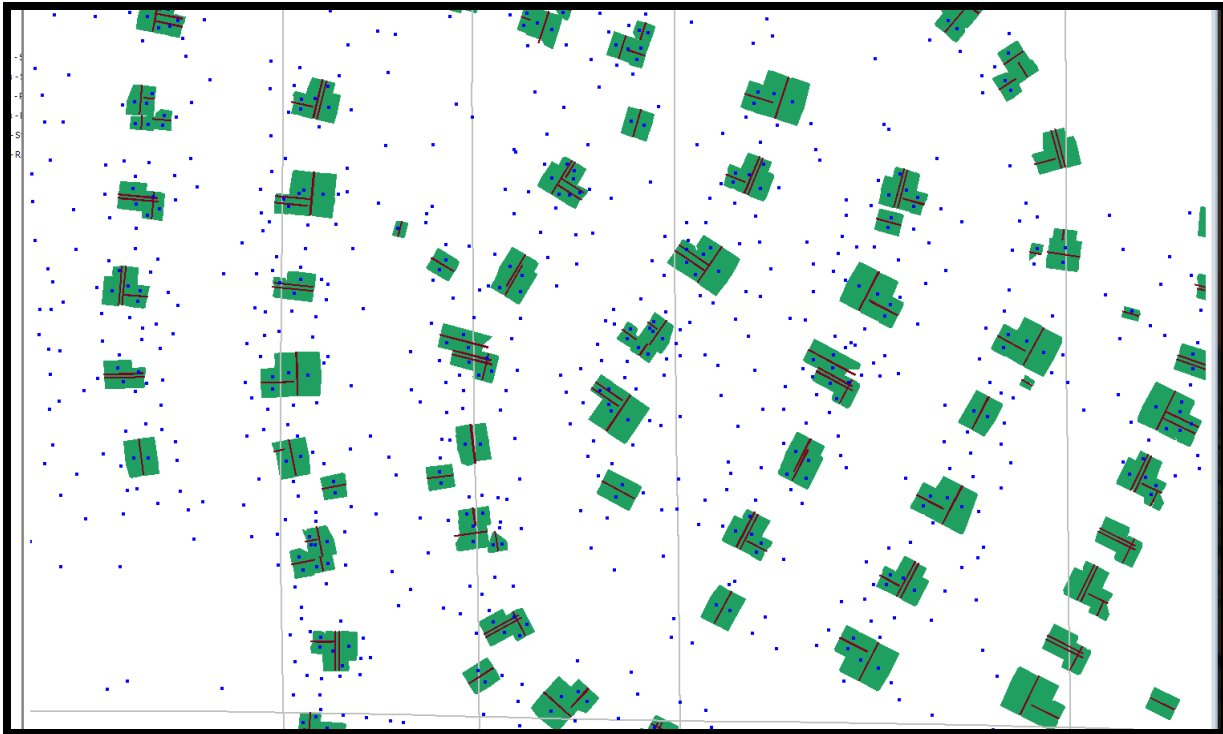

At the conclusion of the self-calibration run the data is quality checked with LMS plots

Plot of plane vertical distances from datum plane.

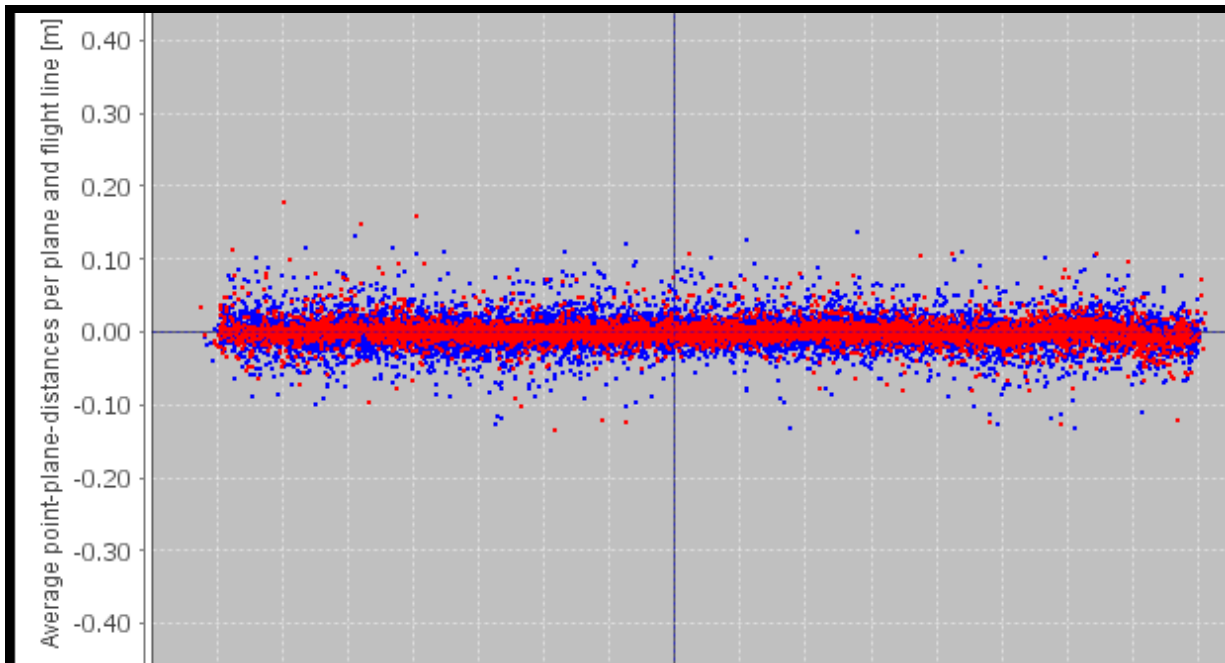

Plot of height differenced between flight lines. (Green=less than 5cm).

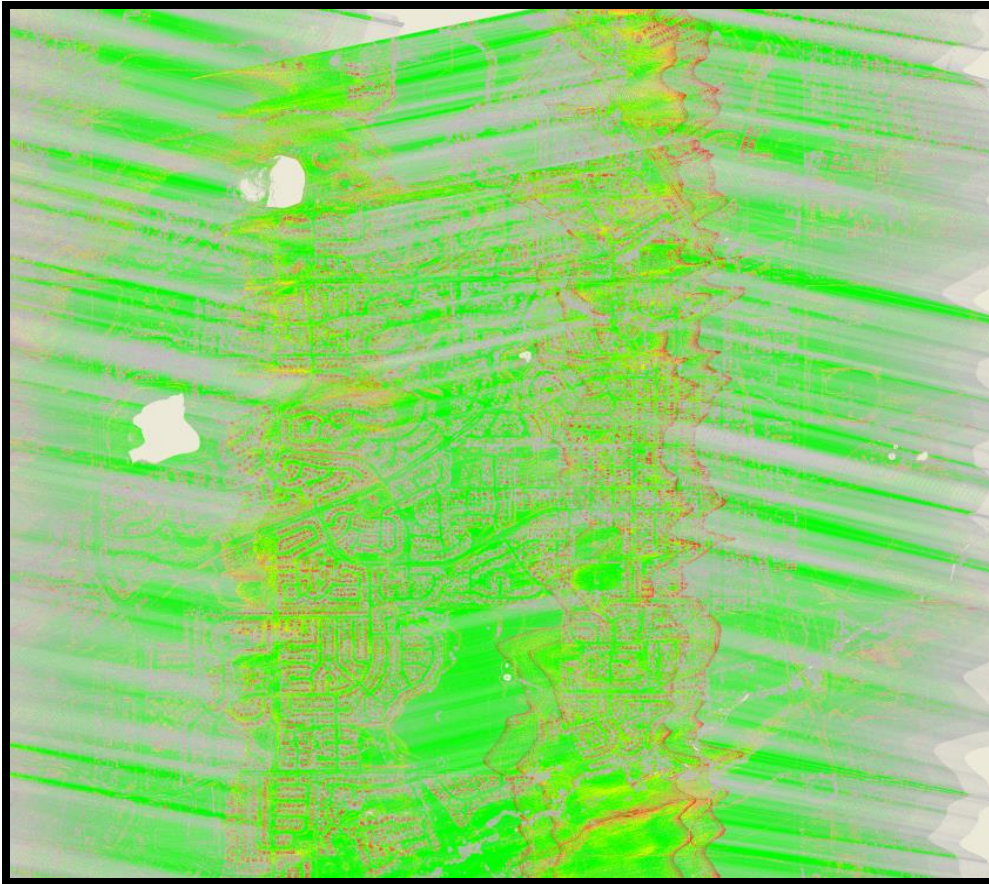

Plot of point densities. (Red=5-9 points per cell, green 10+ points per cell).

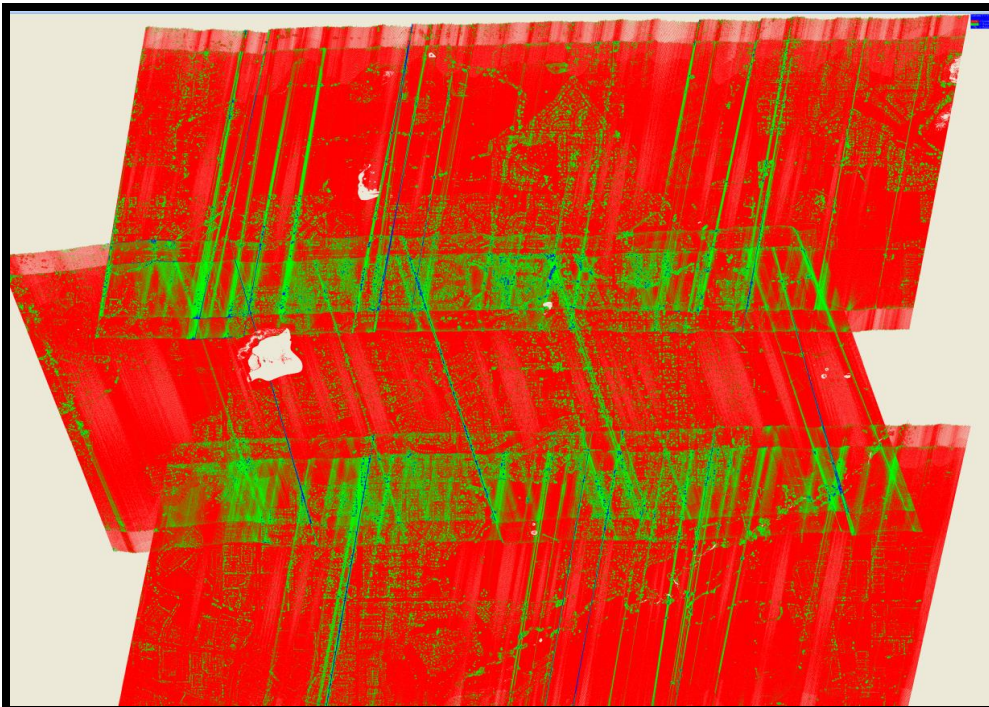

A Flight Line Separation Raster image is generated in Merrick Advanced Remote Sensing Software (MARS®), in this example ground returns from multiple flight lines that are fitting within 3 centimeters are colored green.

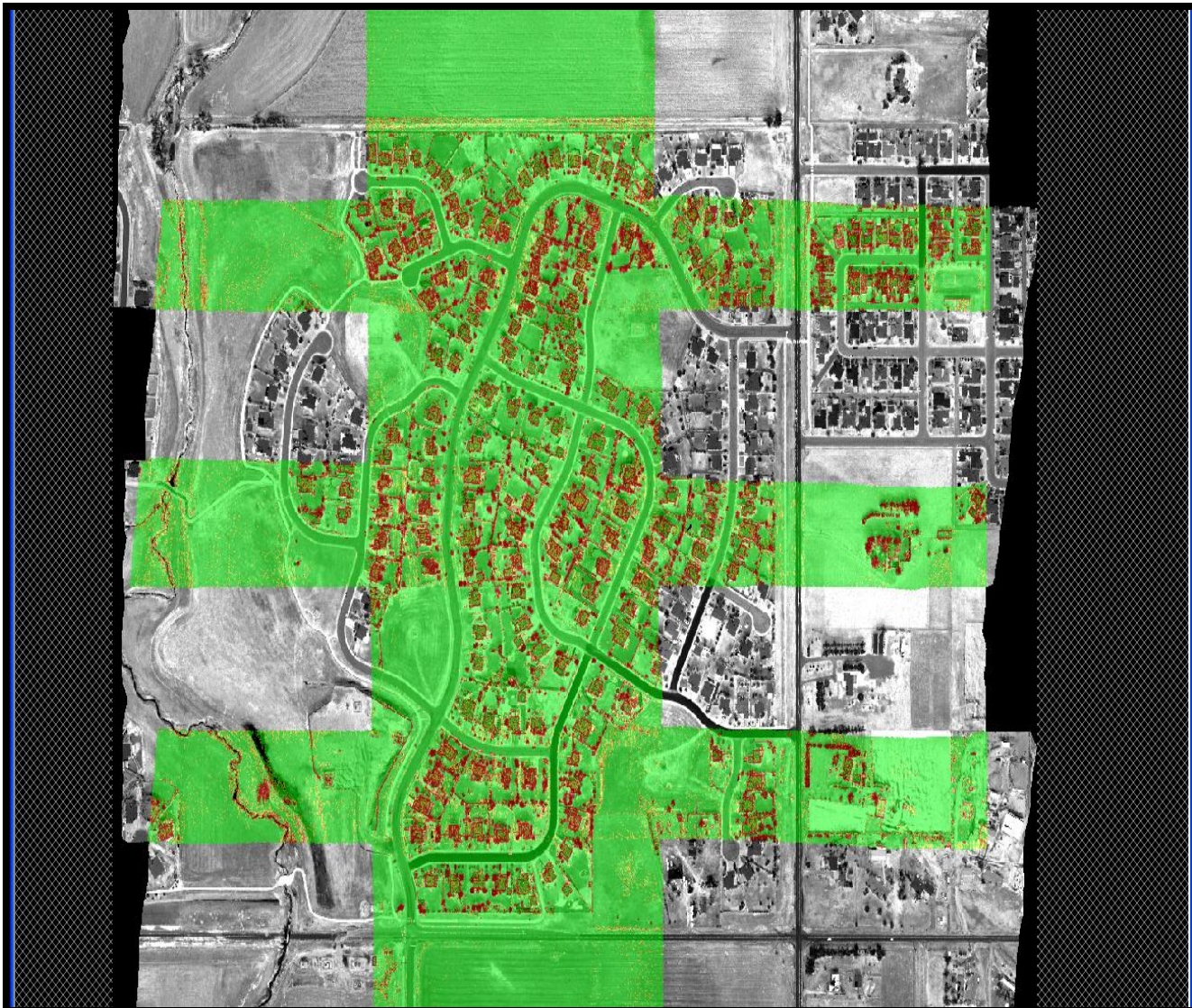

MARS® tests for internal relative vertical accuracy using inbound and outbound scan values. Again, Green is showing inbound and outbound scan data fitting to 3 centimeters.

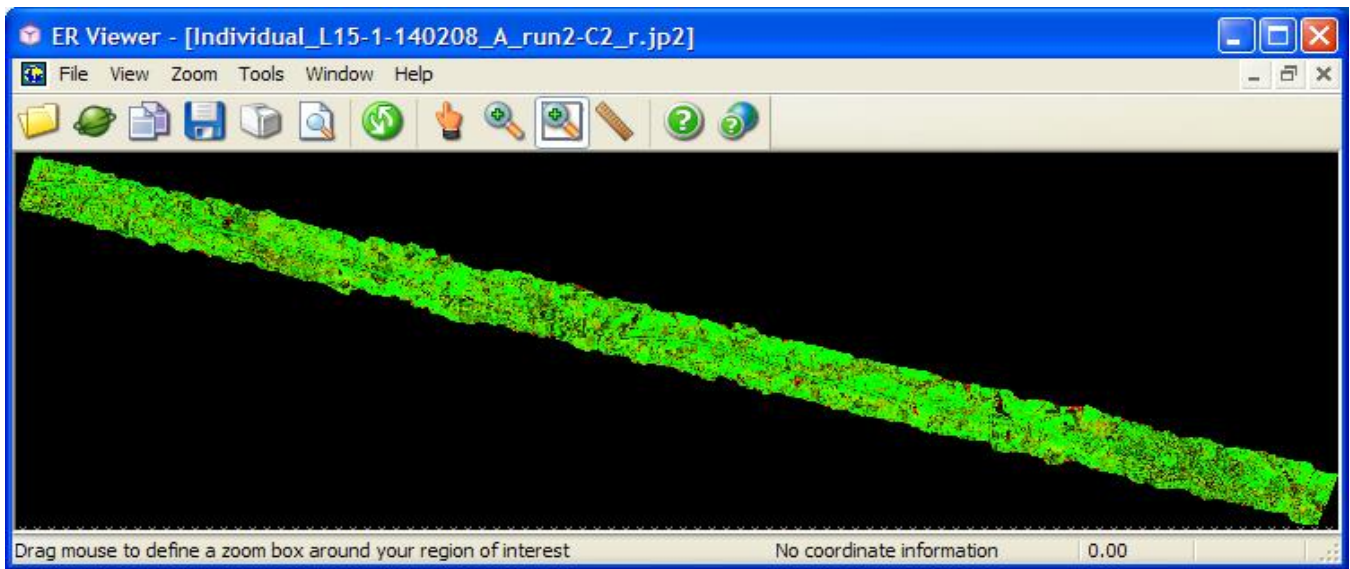

Building cross sections are checked for good alignment. Pitch and heading are checked on roof planes parallel to the flight direction.

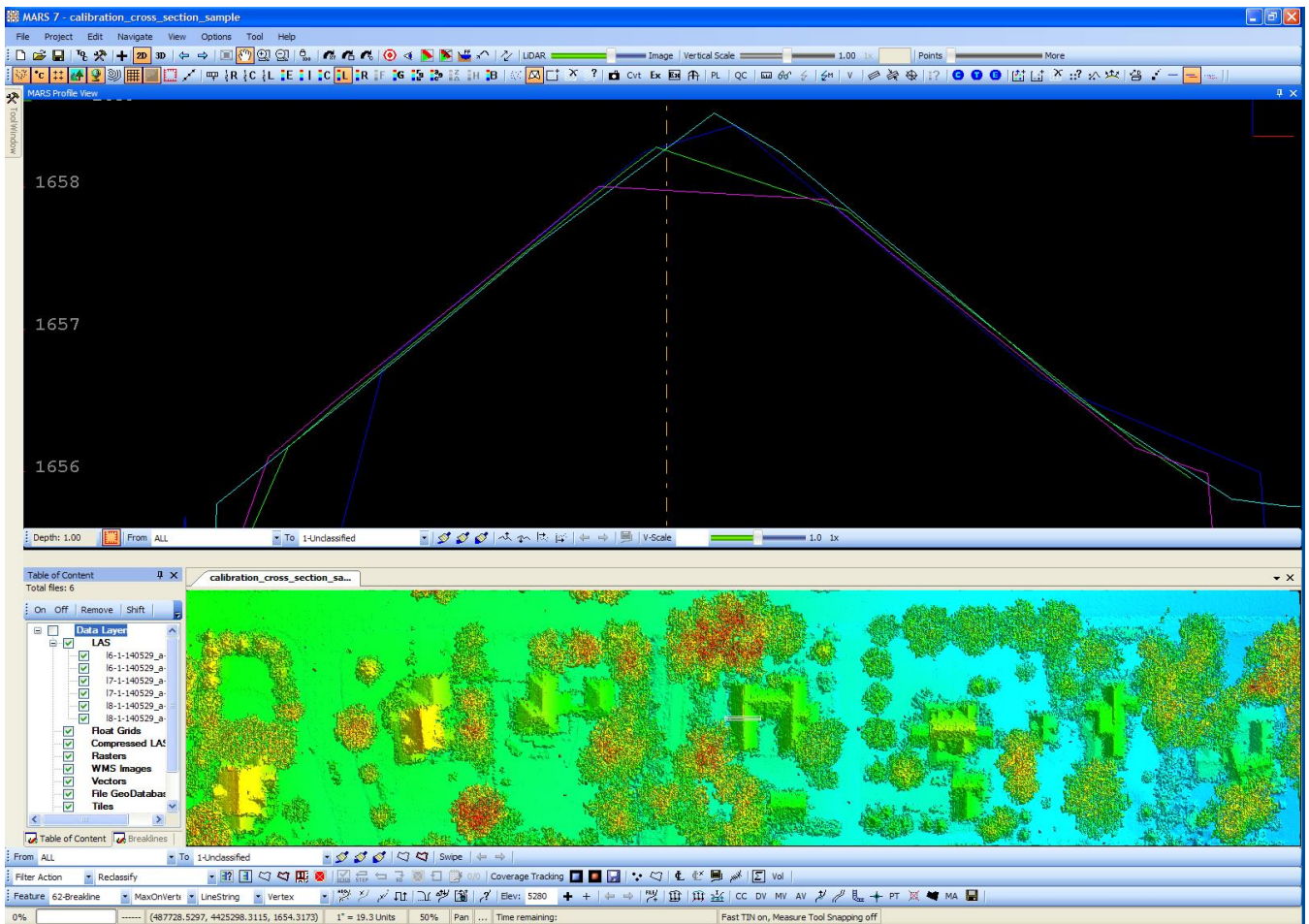

Roll and scale are checked on roof planes perpendicular to the flight direction.

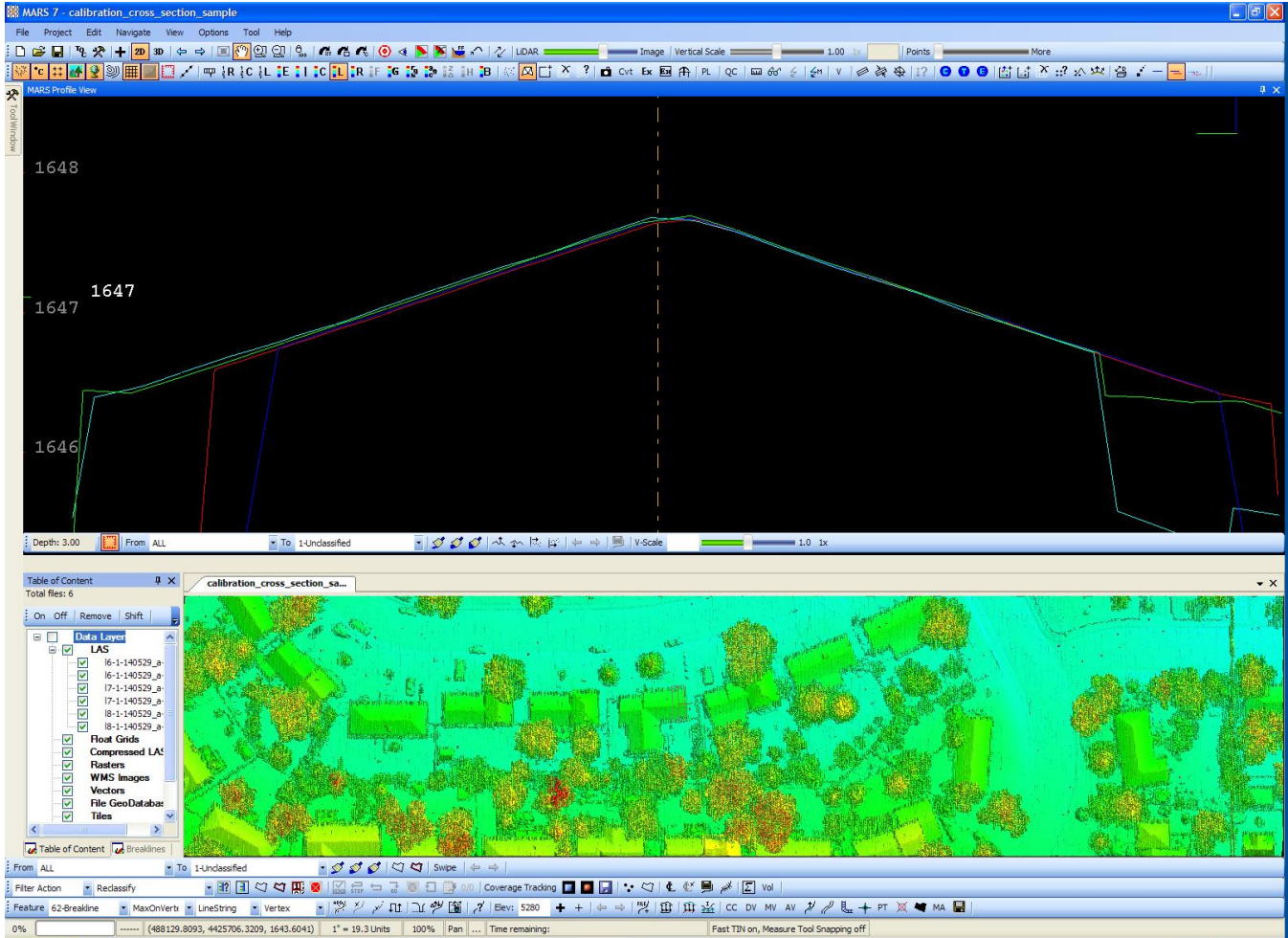

The LMS program outputs a "LCP" file with all the correction parameters. The calibration process may be run several times until the boresight adjustments are acceptable. When the boresight solution is acceptable the LCP file adjustments are saved and also applied to subsequent projects. Each new project is again analyzed and when the adjustment biases show too much drift a new boresight calibration is run. The LCP file may hold calibration tolerances for several projects.

Block LAS Production Processing Procedures

The LMS production mode is run on each flight line to further tie the final lidar LAS flight line files tightly together. Production settings allow scan angle scale, scan angle lag to float and allows elevation to move slightly during flight line to flight line comparison thus further tying flight lines together. A cross flight with locked elevation data is used for controlling flight line elevations.

A block of data is selected to process with LMS production settings. Data collected during turns at the ends of flight lines is deselected (light blue lines).

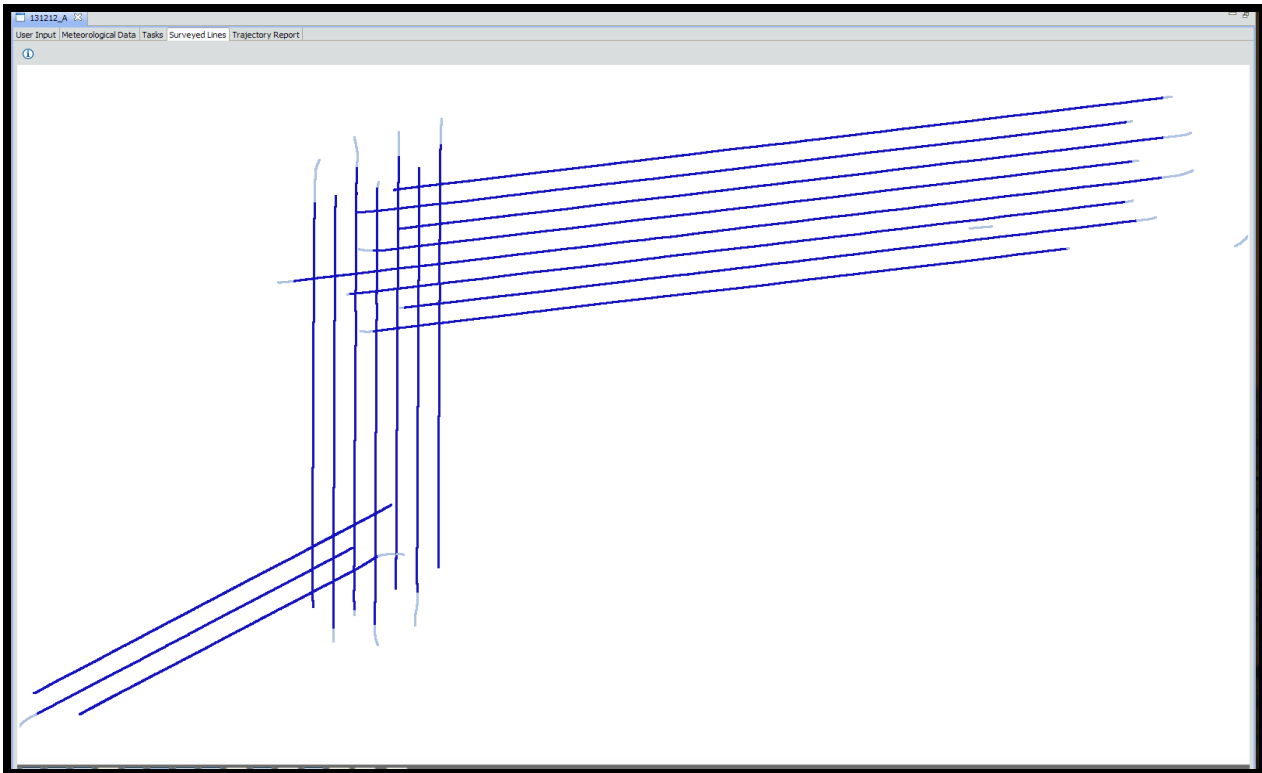

As in self-calibration the LMS production program analyses ground, roof planes and rooflines. One cross flight is locked in elevation and all other lines are adjusted to it. Unlike the calibration site the distribution of roof planes is usually much less dense. Here matched ground tie planes are blue.

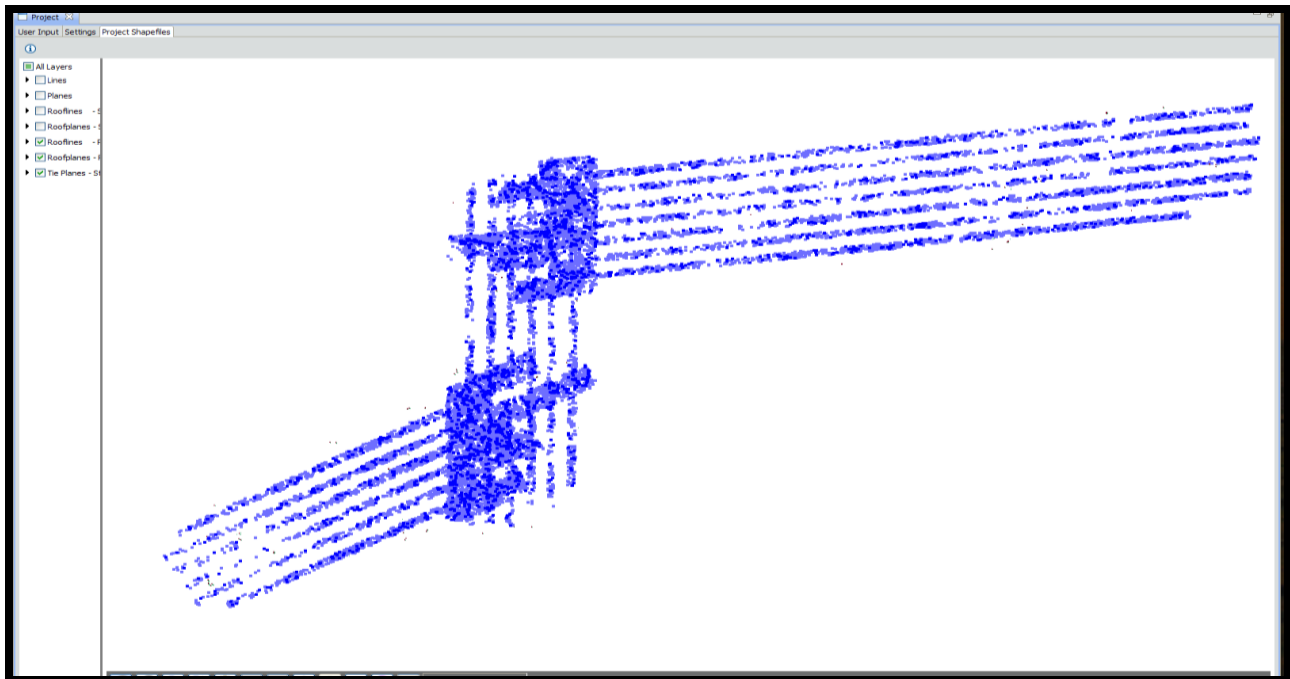

The same quality control outputs used to check self-calibrations are available to analyze the production run. Output plots are again available in LMS and cross sections plus a Flight Line Separation Raster are generated in MARS® to check coverage and quality.

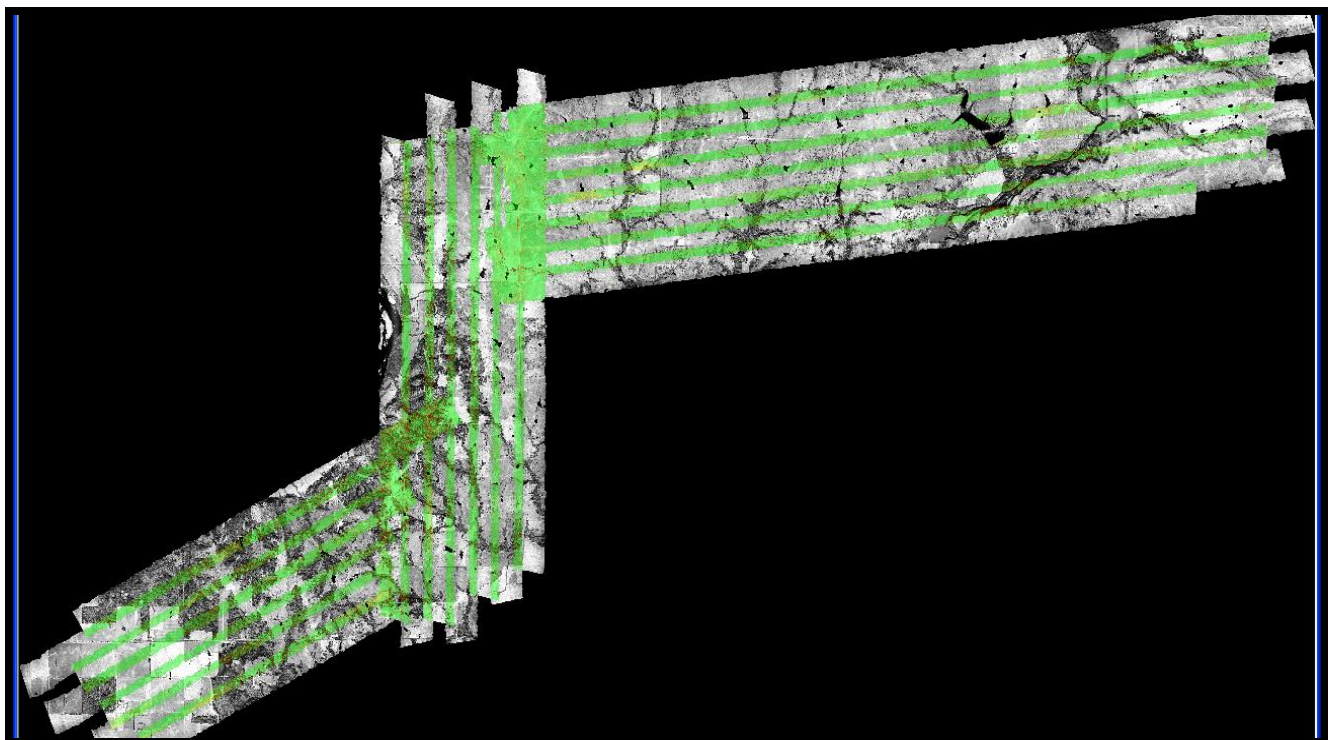

Correcting the Final Elevation

After all the lines are tied together a ground control network is imported into MARS®. The ground control network may be pre-existing or collected by a licensed surveyor.

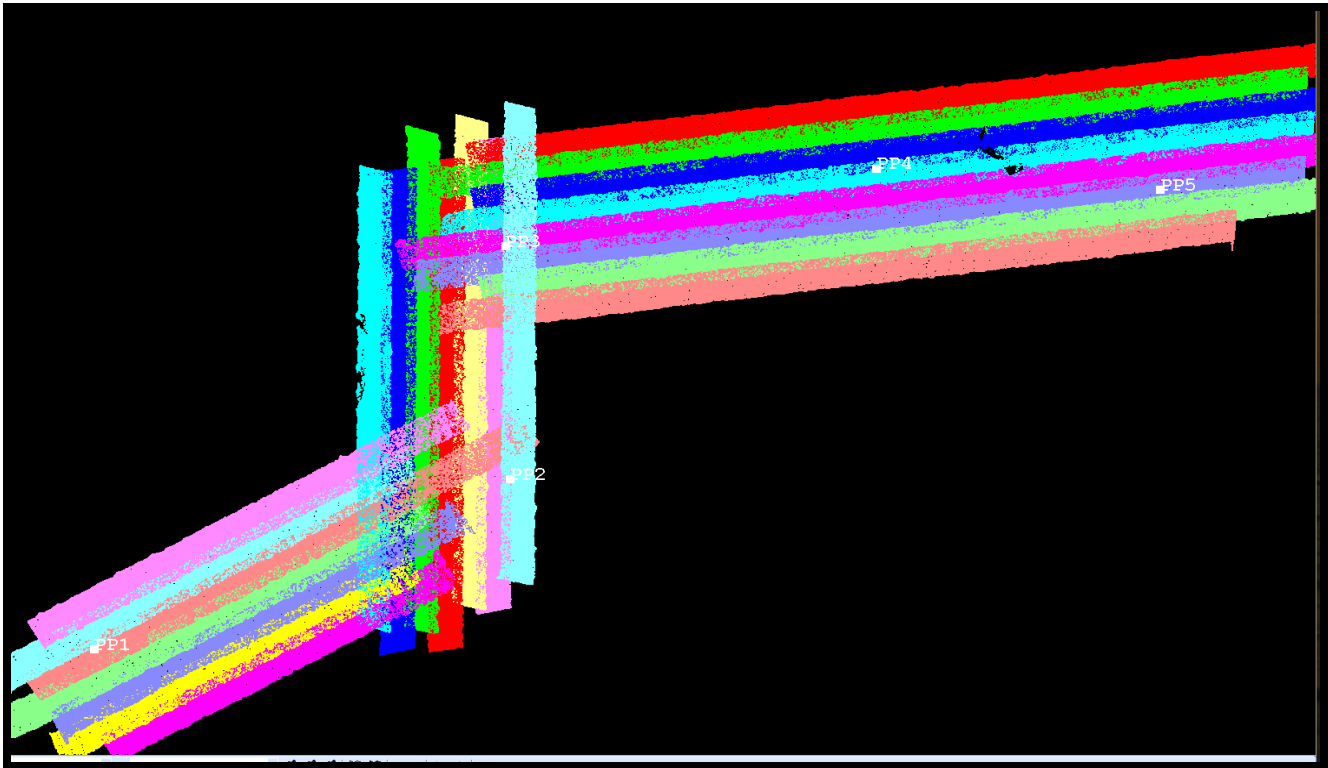

The next step is to match the ground control elevations to the lidar data set. A control report is run and the data set is shifted slightly to zero out the average elevation error and points checked for quality.

The final step before boresighted, leveled LAS files are ready for filtering is to run the MARS® QC Module on the block data. The Boresighted lidar QC Report outputs individual reports on Point Density, Nominal Pulse Spacing, Data Voids, Spatial Distribution, Scan Angles, Control Report, Flight Line Separation, Flight Line Overlap, Buffered Boundary, LAS Formats, Datums and Coordinates.

These reports are checked with the required specifications in the Project Management Plan.